

REVISIONS				
SYN	ECN	DESCRIPTION	DATE	APPROVED
A				

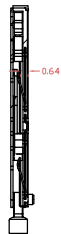

二 A-A

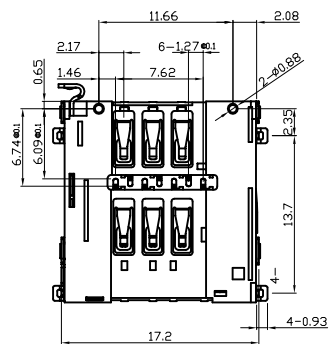
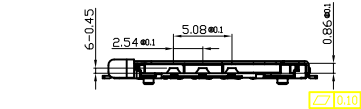
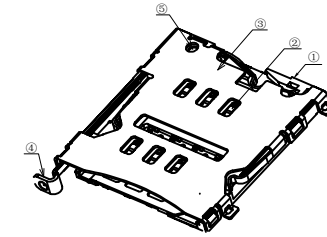
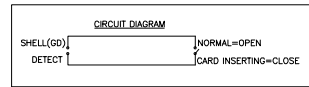
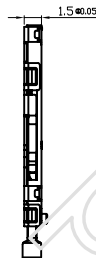
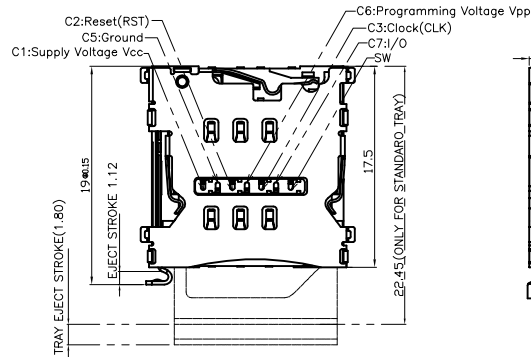
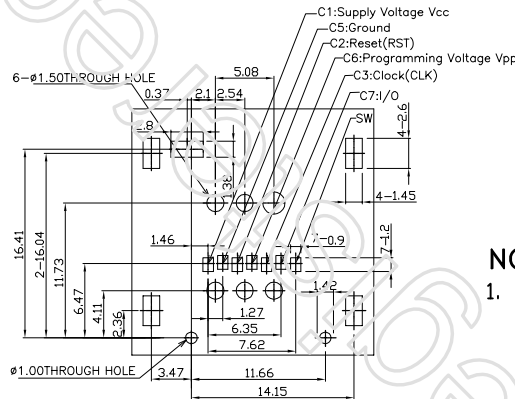

PCB LAYOUT

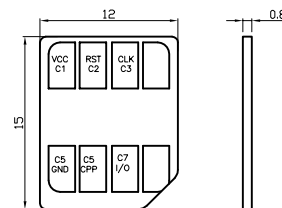

NOTE:

- ELECTICAL CHARACTERISTICS:
 - VOLTAGE:30V DC.MAX
 - LOW LEVEL CONTACT RESISTANCE:30 mohms MAX.INITIAALLY
 - DIELECTRIC WITHSTANDING VOLTAGE:500V AC MIN.FOR 1 MINUTE
 - INSULATION RESISTANCE :100Mohms MIN.(DC 500V FOR 1 MINUTE)
- MECHANICAL CHARACTERISTICS:
 - DURABILITY:1500 CYCLES
 - OPERATING FORCE<INSERTING & WITHDRAWAL>:1N-10N
- ENVIRONMENTAL CHARACTERISTICS:
 - RANGE:-25°C TO 85°C.(INCLUDING TERMINAL TEMP.RISE
 - STORAGE TEMP :-40°C TO 85°C
- QUANTITY OF PRODUCTS:1000PCS/REEL MIN
- PLEASE CONTACT SALES REPRESENTATIVE TO VERIFY PRODUCT DETAILS

UNLESS OTHERWISE SPECIFIED TOLERANCES U.S. METRIC .X +/- 0.10 .XX +/- 0.05 .XXX +/- 0.03 FRACTIONS +/- ANGLES +/- 1°	APPROVAL	DATE	深圳市鑫南天科技有限公司 Shenzhen XinNanTian Industrial Co.,Ltd
	DRAWN ly.yf	05/11/06	
FOR MATERIALS AND FINISHES SEE NOTES	DRAWING FILE : \\DRAWING\BC\BC-2718L-S-01-X		TITLE MICRO SIM PUSH H=1.5mm
REMOVE SHARP EDGES	ANGLE OF PROJECTION		SIZE DRAWING NO. A3 MPS-0605-P15
DIMENSIONS U.S. INCHES METRIC MM			REV. B
	SCALE	NONE	SHEET 1 OF 1