

REV	LTR	DESCRIPTION	DATE	APPROVED
A0			20160406	

备注 (NOTE):

1. 材质:
  - 1-1. 塑胶: PA9T 黑色UL94V-0, 符合环保.
  - 1-2. 端子: C2680-H T, 镀半金亮锡1U".
  - 1-3. 外壳: SUS201-1/2H 镀镍48H, 符合SGS环保.
2. 尺寸标注事项:
  - 2-1. 图示有标注"▲"记号者为重点尺寸.
  - 2-2. 图示所有标注" "尺寸为首样全检尺寸.
  - 2-3. 图示所有标注" "尺寸为Cpk检验尺寸.
3. 电气特性:
  - 3-1. 接触区: 接触电阻40mΩ Max, 允许10mΩ变化量. 测试条件: 20mv, 100mA下测量.
  - 3-2. 接触电流: 3A VBUS引脚; 1.25A用于GND引脚; 其他引脚为0.25A.
  - 3-3. 额定电压: 30V.
  - 3-4. 耐电电压: 100VR. M. S.
  - 3-5. 绝缘电阻: 至少100兆欧.
4. 机械性能:
  - 4-1. 插入力: 0.51-2.04Kg, 拔出力: 0.51-2.04Kg
  - 4-2. 插拔次数: 10000次.
5. 工作环境: -20°C to +85°C.
6. 测试要求:
  - 6-1. 吃锡测试: 95%, 盐雾测试: 24HR MIN.
7. 品质要求事项:
  - 7-1. 产品表面不能刮伤, 划伤压痕, 缺胶, 歪PIN, 起气泡.
  - 7-2. 镀层要均匀, 不能有发黑发白及露铜现象.

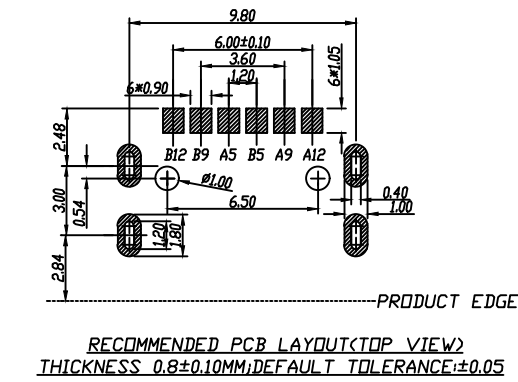
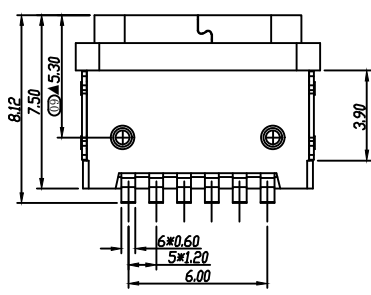
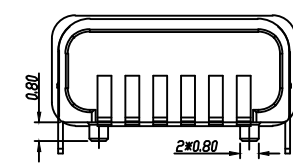
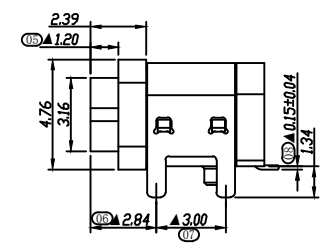
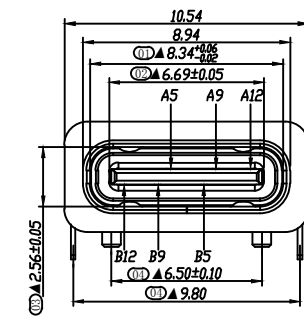
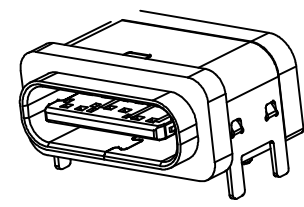
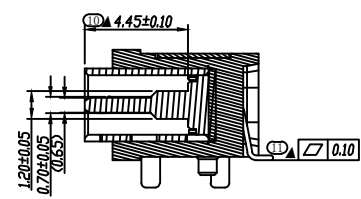
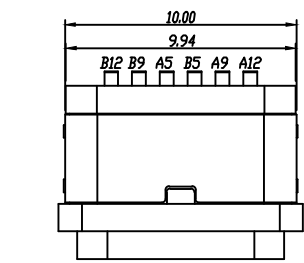

ALL MATERIAL MEET THE FORMAN'S SPEC: ENVIRONMENT-RELATED SUBSTANCES MANAGEMENT TECHNICAL STANDARD

# 深圳市鑫南天科技有限公司

<input checked="" type="checkbox"/> RoHS <input checked="" type="checkbox"/> HF TOLERANCE (UNLESS SPECIFIED) .0±0.30 .00±0.20 .000±0.10	<input checked="" type="checkbox"/> HF 0.°±10° .0°±8° .00°±5°	品名 TITLE: TYPE C 6P 板上SMT防水母座L=7.5mm 带柱四脚DIP防水8级 B款 审核 APPROVE BY: C J L 设计 DESIGN BY: L S W	比例 SCALE: 1:1 张数 SHEET: 1/1 版本 VER.: 2.0	料号: XNT-B040466-0014  单位 UNITS: mm
--	--	--	--	--

These drawings and specifications are Shenzhen Ailiante Electronics Co Ltd. The property should not be copied. Without Shenzhen Ailiante Electronics Co. Ltd. Prior written consent to copy or use in any way

PIN ASSIGNMENTS

PIN	SIGNAL NAME	PIN	SIGNAL NAME
A5	CC1	B12	GND
A9	VBUS	B9	VBUS
A12	GND	B5	CC1